



# Ubiquiti Inc. (UI.com) NAS 使用者年會



# 誰是UI？ - Ubiquiti Inc.®

- 全球第三大網通品牌
- 2005年成立
- 2008年於台灣註冊
- 2011年NASDAQ上市
- 2019更名為Ubiquiti Inc.轉至NYSE
- 目前市值超過200億美金
- 100%FW及HW研發位在台灣
- 台灣為全球研發總部



# UI已成為全球第三大網通品牌

Ubiquiti Inc

326.91 USD

0.00 (0.00%)

Mar 3, 4:00 PM EST · Disclaimer

NYSE: UI

+ Follow

1 day | 5 days | 1 month | 6 months | ytd | 1 year | 5 years | max

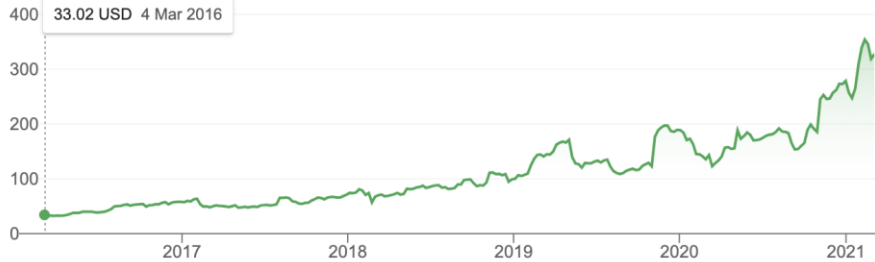

Open	-	Mkt cap	20.53B	Prev close	326.91
High	-	P/E ratio	40.60	52-wk high	362.89
Low	-	Div yield	0.49%	52-wk low	110.01



Worldwide Top 5 Enterprise WLAN Companies, 2019Q2 - 2020Q2 Revenue (\$M)

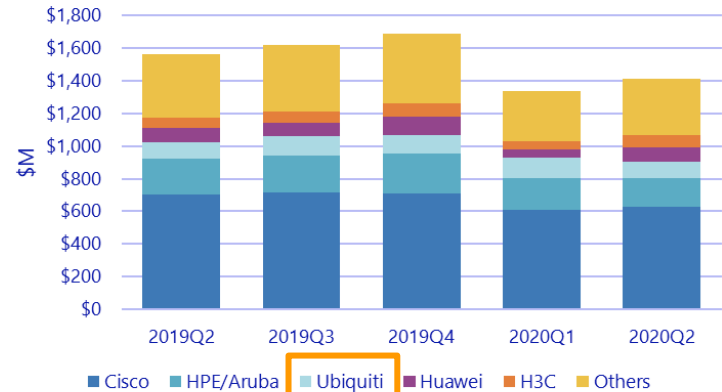

Source: IDC 2020

# UI全球佈局

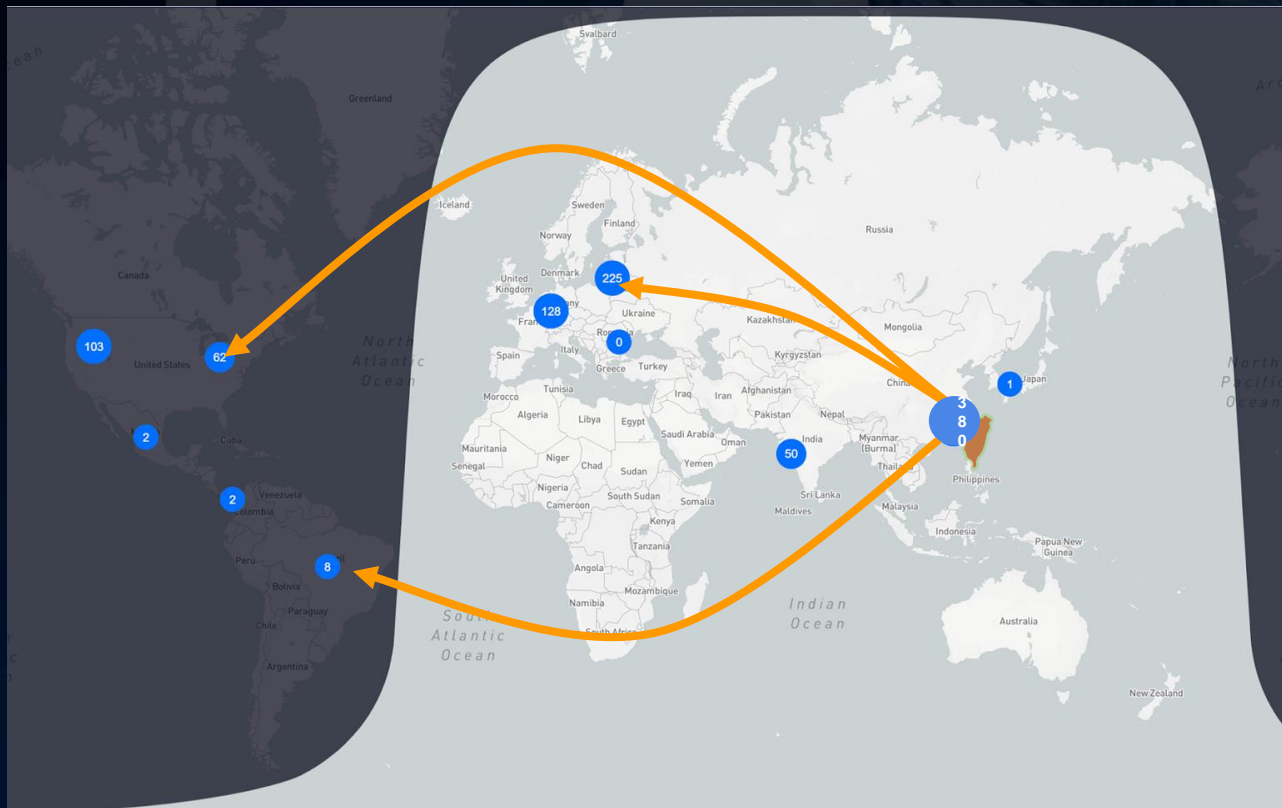

- Barrington, IL
- Brazil
- Broomfield, CO
- Canada - British Columbia
- Canada - Ontario
- Canada - Saskatchewan
- Chicago, IL
- CM-Foxconn, China
- CM-Lite-On, China
- Columbia
- Costa Rica
- France
- Hangzhou, China
- Hsinchu, Taiwan
- Ireland
- Japan
- Kaunas, Lithuania
- Kiev, Ukraine
- Krakow, Poland
- London, UK
- Memphis, TN
- Mexico
- Mumbai, India
- Nanning, China
- Netherlands
- New York, NY
- Orange, CA
- Pilsen, Czechia
- Portland, OR
- Prague Warehouse, CZE
- Prague, Czechia
- Riga, Latvia
- Romania
- Salt Lake City, UT
- San Jose CA, USA
- Seattle, WA
- Shanghai, China
- Shenzhen, China
- South Korea
- Stockholm, Sweden
- Suzhou, China
- TPE-SongRen 105
- TPE-Exchange Squire
- TPE-ZhongShan
- USA Remote CST
- USA Remote EST
- USA Remote MST
- USA Remote PST
- Xiamen, China

# Ubiquiti Inc. 創辦人 Robert Pera 對台灣有深厚情感，持續投資13年

## #45 Robert Pera

Chief Executive Officer, Ubiquiti



### REAL TIME NET WORTH

**\$18.8B** as of 3/2/21

▼ \$500 M | 2.59%

### ON FORBES LISTS

#45 **Forbes 400 2020**

#208 **Billionaires 2020**

#61 **Richest In Tech 2020**

#7 **America's Richest 2020**

## Bloomberg Billionaires Index

View profiles for each of the world's 500 richest people, see the biggest movers, and compare fortunes or track returns.

As of 2021年3月2日

The Bloomberg Billionaires Index is a daily ranking of the world's richest people. Details about the calculations are provided in the net worth analysis on each billionaire's profile page. The figures are updated at the close of every trading day in New York.

Rank	Name	Total net worth	\$ Last change	\$ YTD change	Country
1	Jeff Bezos	\$184B	+\$2.93B	-\$5.86B	United States
2	Elon Musk	\$184B	+\$9.75B	+\$14.5B	United States
3	Bill Gates	\$137B	+\$1.84B	+\$4.96B	United States
146	Robert Pera	\$14.6B	+\$783M	+\$2.49B	United States
5	Elon Musk	\$184B	+\$9.75B	+\$14.5B	United States

1

Ubiquiti佩拉、Tesla馬斯克跟Apple賈伯斯，21世紀傳奇創業家的共通性：  
結合感性與理性的完美體驗

2

為什麼UI會將研發總部移往台灣？打造設計者與開發者的天堂

3

創意點子源源不絕，UI的成功秘訣-勇於挑戰、追求卓越

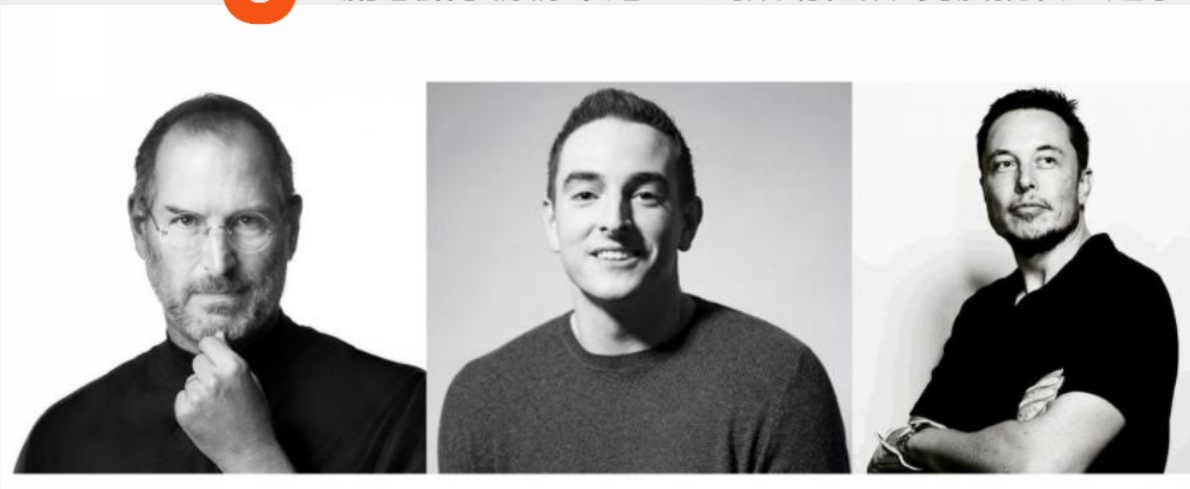



無線時代，無限可能：不久的未來，我們將用科技搖滾生活。

## 成立六年成功上市的獨角獸：世界第三大無線網通公司Ubiquiti Inc.，第一款產品竟與台灣有關？

2019/08/26，評論

無線時代，無限可能：不久的未來，我們將用科技搖滾生活。

### 一年營收10億美元的跨國企業，沒有龐大銷售部門卻貨銷200國、年成長30%？

2019/10/05，評論

**INSIDE** 報導 ▾ 數位轉型 ▾ 半導體 ▾ 網路 ▾ 商業 ▾ 焦點 ▾

## 歐美市佔率前三的無線網通品牌，Ubiquiti Inc. 善用台灣資源成為IT硬體產業超新星

2019/08/26 · 廣編企劃 · 羅伯特佩拉、光寶代工、和碩代工、路由器、UI、鴻海代工、IT、Robert Pera、Wi-Fi、

# Ubiquiti 全球年複合成長近23%

UI全球營業收入（百萬/美金）

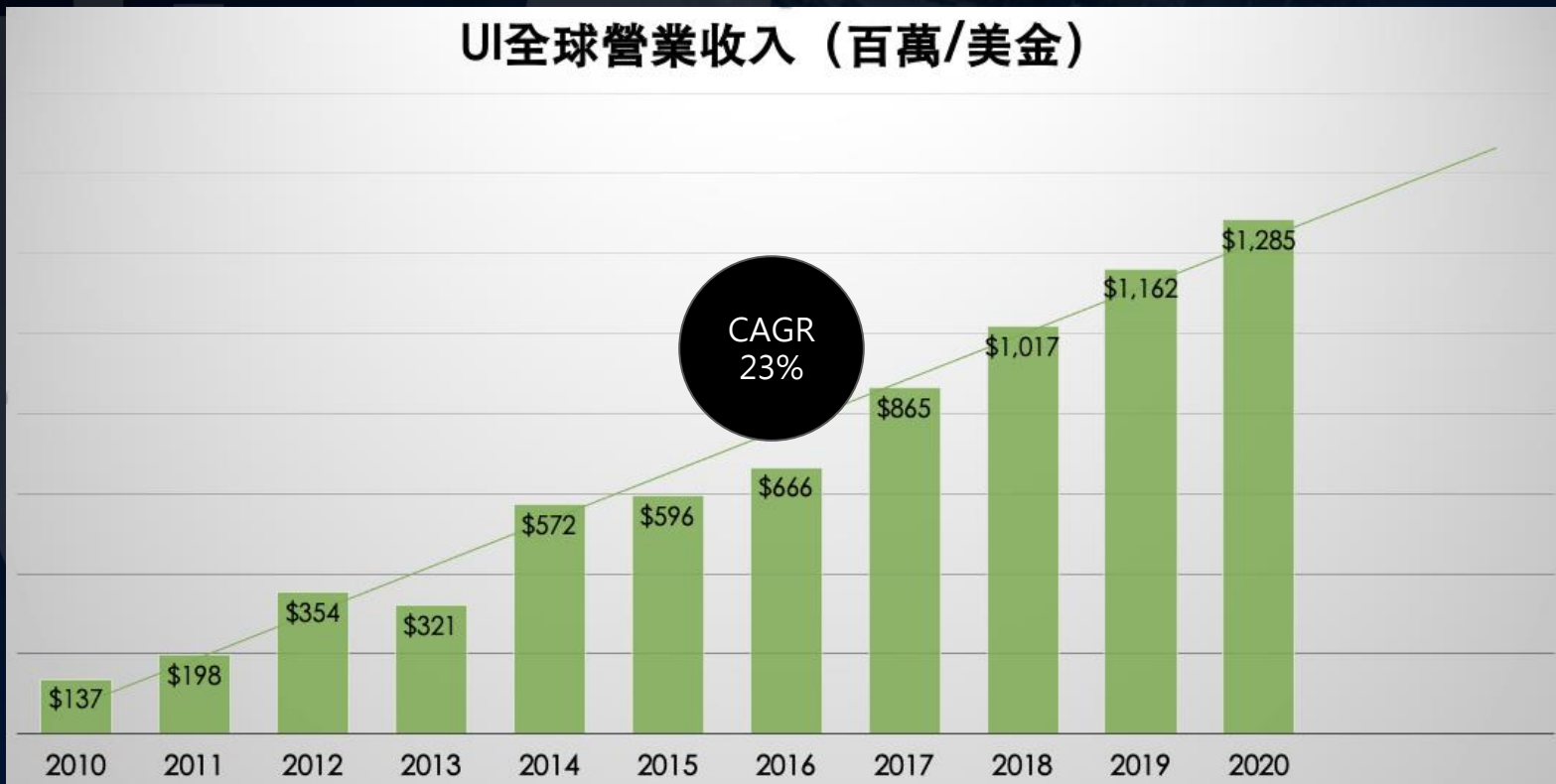



# UI在台深耕13年平均每年成長近20%

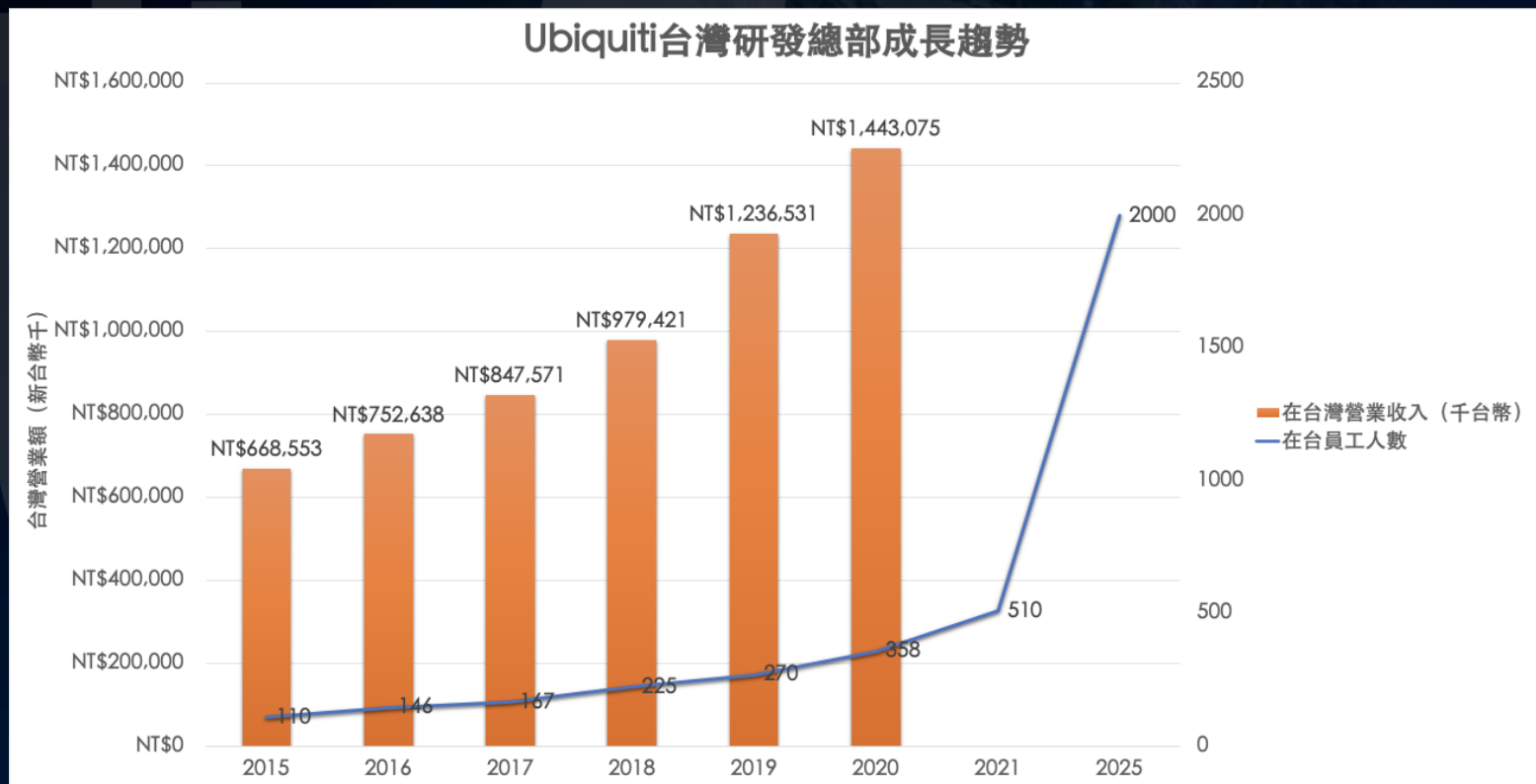

# UI全球研發總部特色

- 全球研發總部
  - 決策總部，並非一般分公司
  - 大量利用台灣人才及研發資源
  - 長期連續十三年以上的深耕及投資
- 台北為UI品牌發源地，非傳統台商代工廠
  - 創造台北品牌之都價值
  - 繼續培養大量品牌及設計專業人才
- 完整產業鏈，帶動大台北發展
  - 工業設計、機構設計
  - 硬體研發、軟體開發
  - 量產團隊
- 吸引全球人才



# UniFiOS，及新成員 UniFiAccess

- 網路/門禁/監控/通話/照明...

# Ubiquiti UniFi SDN UDM Pro

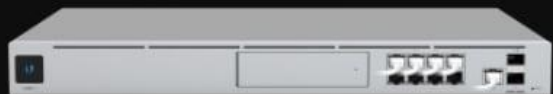

Status	<a href="#">Update to v1.9.1</a>
Firmware Version	1.9.0
Last Checked	March 11, 2021 at 9:45 AM
Release Channel	Official <span>▼</span>



## Network

Status	Up to Date
Version	6.1.64
Release Channel	Beta



## Protect

Status	Stopped
--------	---------

Start Protect



## Access

Status	Stopped
--------	---------

Start Access



## Talk BETA

Status	Stopped
--------	---------

Start Talk



## LED

Status	Stopped
--------	---------

Start LED

UniFi® Access

重新定義門禁  
從安裝實施到用戶體驗的貼心設計



### 直觀的用戶體驗

易於使用，簡單而優雅的產品設計。



### 無縫安裝

以太網連接，PoE 供電。  
支持大多數門禁控制和門鎖品牌。



### 多站點可擴展性

充分考慮多樓層入口和大型場景應用

# 安全、可擴展、且強大

無縫集成到 UniFi OS 集中管理

[立刻試用 >](#)

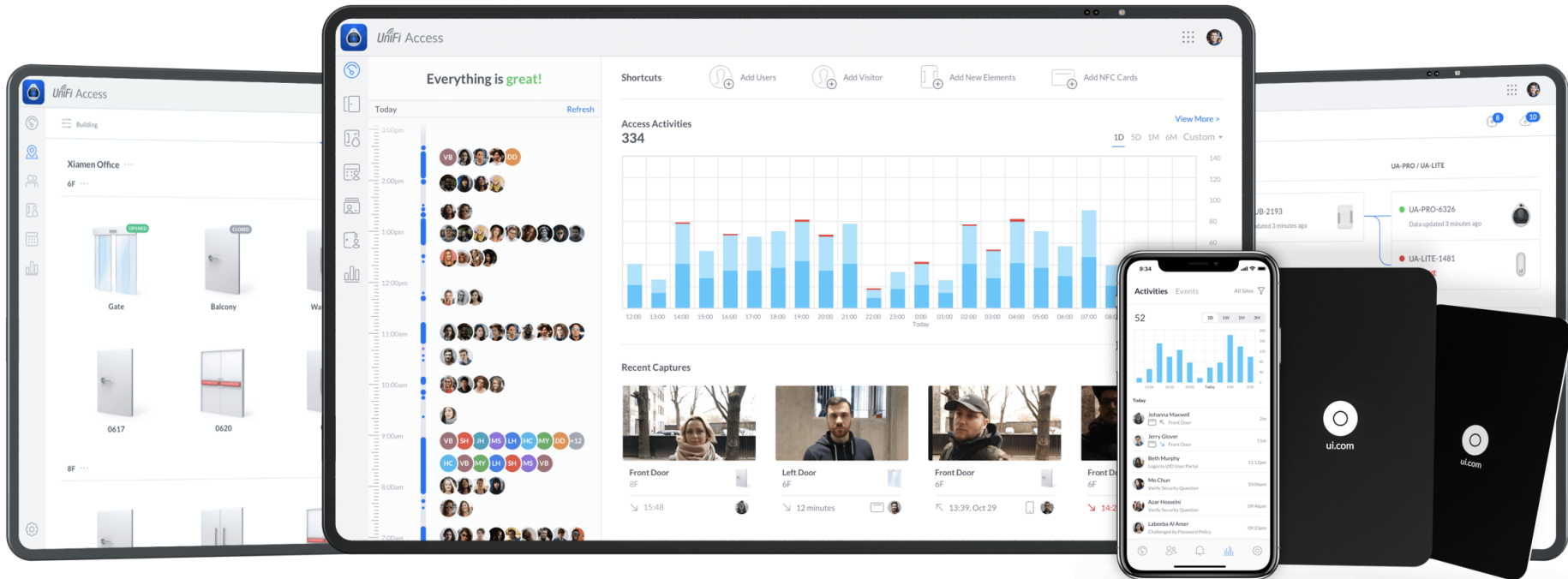

## 強大的控制

定義策略並管理  
訪客訪問



## 報告和日誌

分析日誌文件並創建報告



## 無授權費用

定價合理、無需任何許可費用  
軟件和新功能更新迅速



# 無縫網絡集成

效能強勁、選型豐富、安裝配置簡單、外觀符合現代審美，可滿足各種應用場景需求。

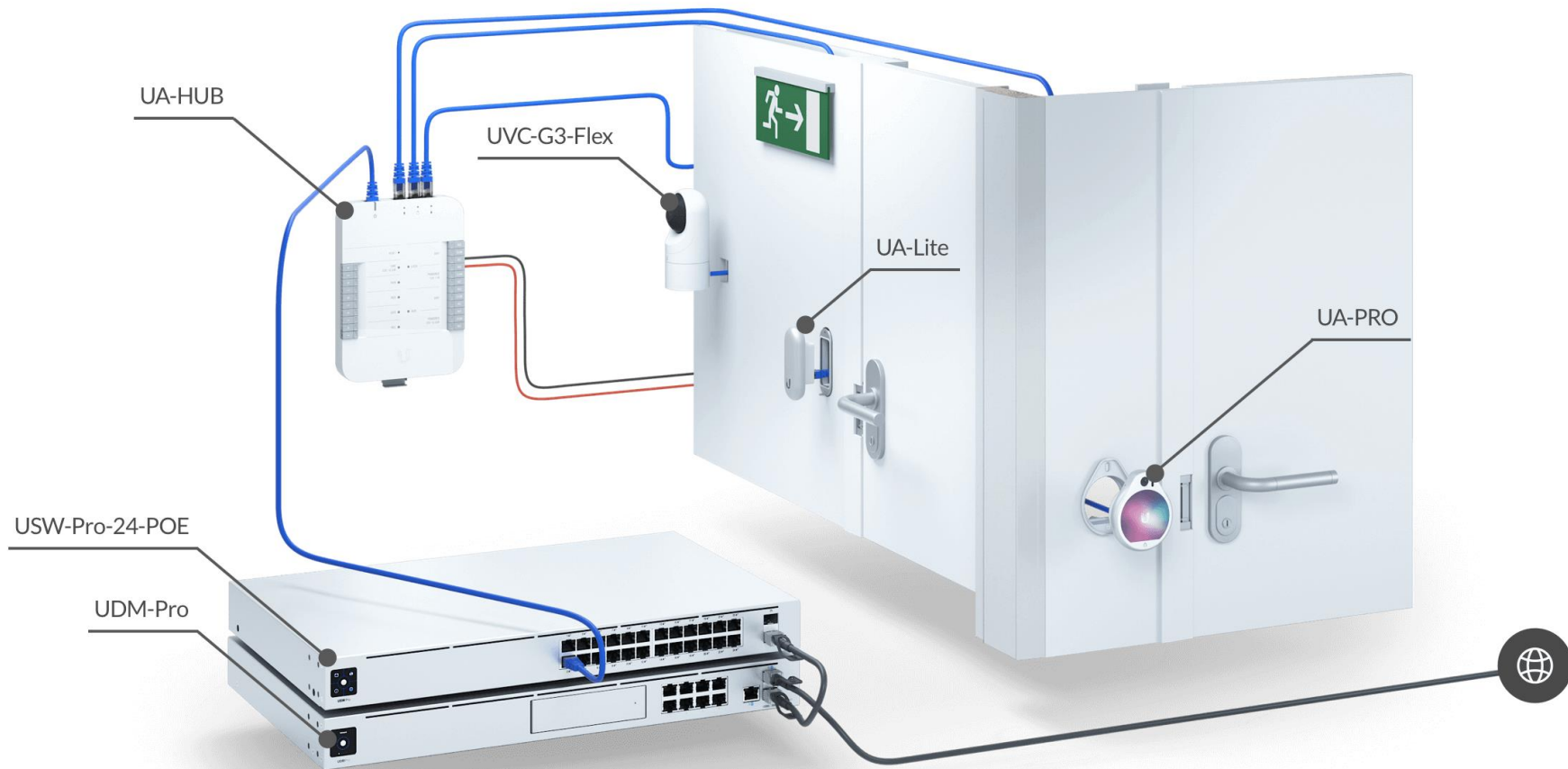



## 帶觸摸屏的交互式讀卡器

現貨

型號: UA-Pro

NFC

手機接入\*

門鈴\*

幾乎所有擁有 NFC 功能的設備或卡都可以用來開門。我們建議使用 UA 卡以獲得最佳的智能卡安全性，但是您也可以使用現有的 NFC 卡。

立即購買

# UniFi Talk 支持雙向視頻通話\*

使用 UniFi Talk 和 UA-Pro 在門口迎接您的客人

\*敬請期待



## 與大多數電子鎖兼容

UniFi Access 可與大多數電動鎖止，磁力鎖和電子門鎖配合使用

電動鎖

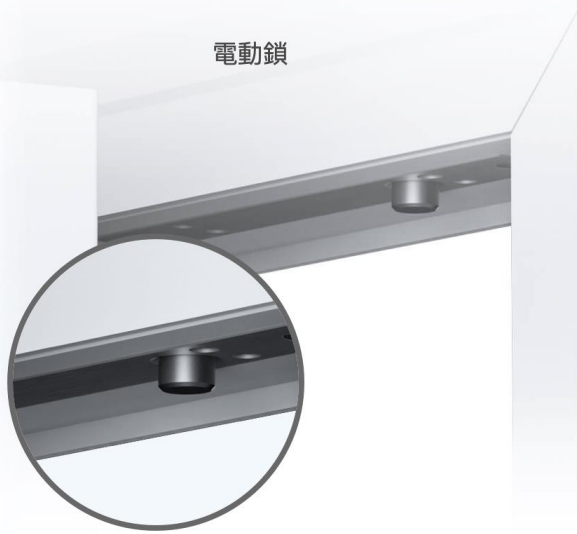

磁力鎖

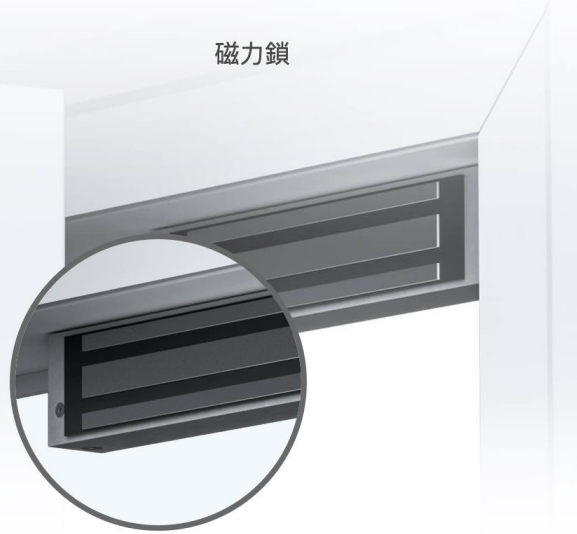

電子門鎖

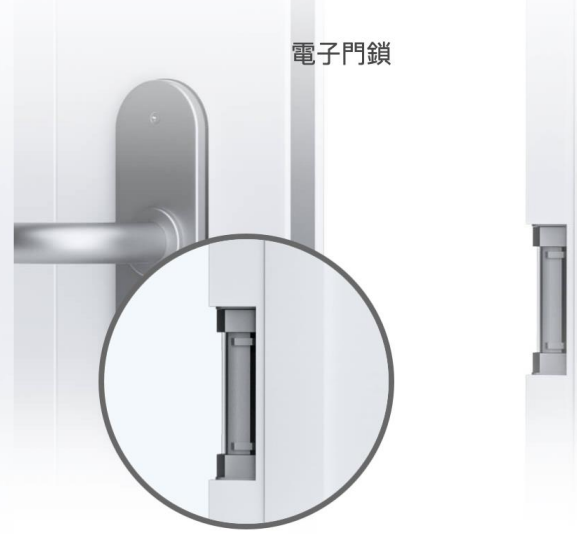

# 案例















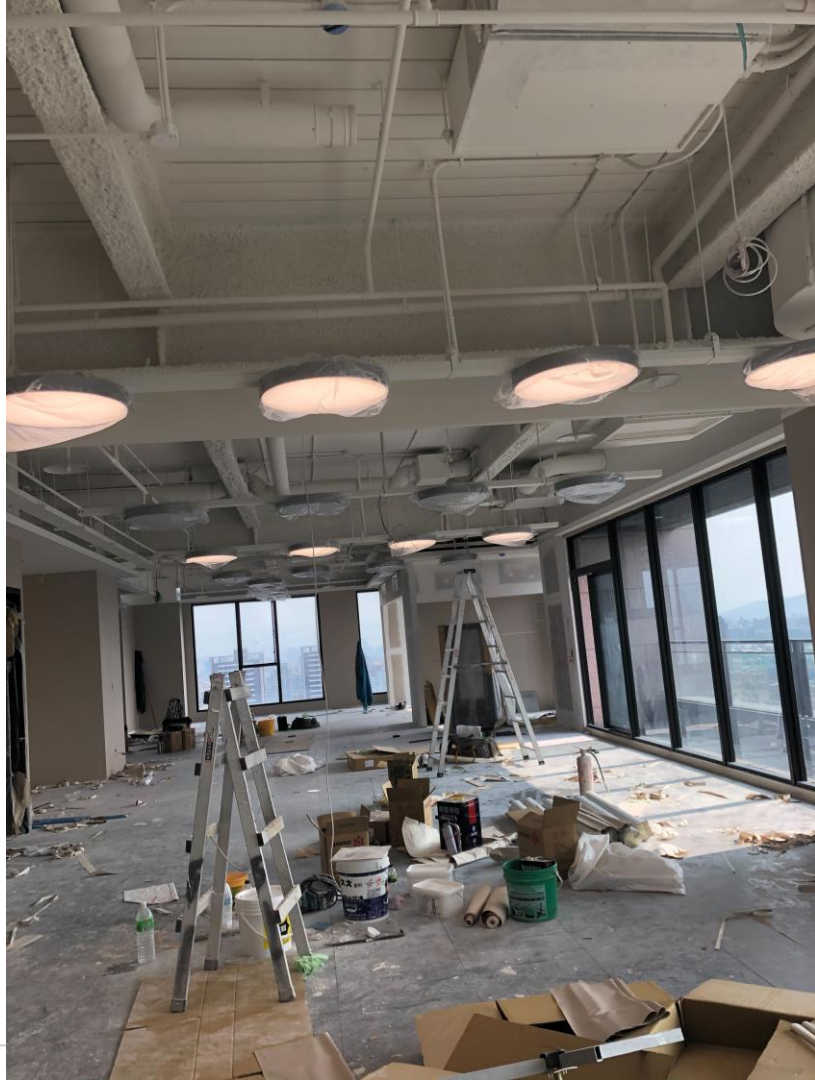











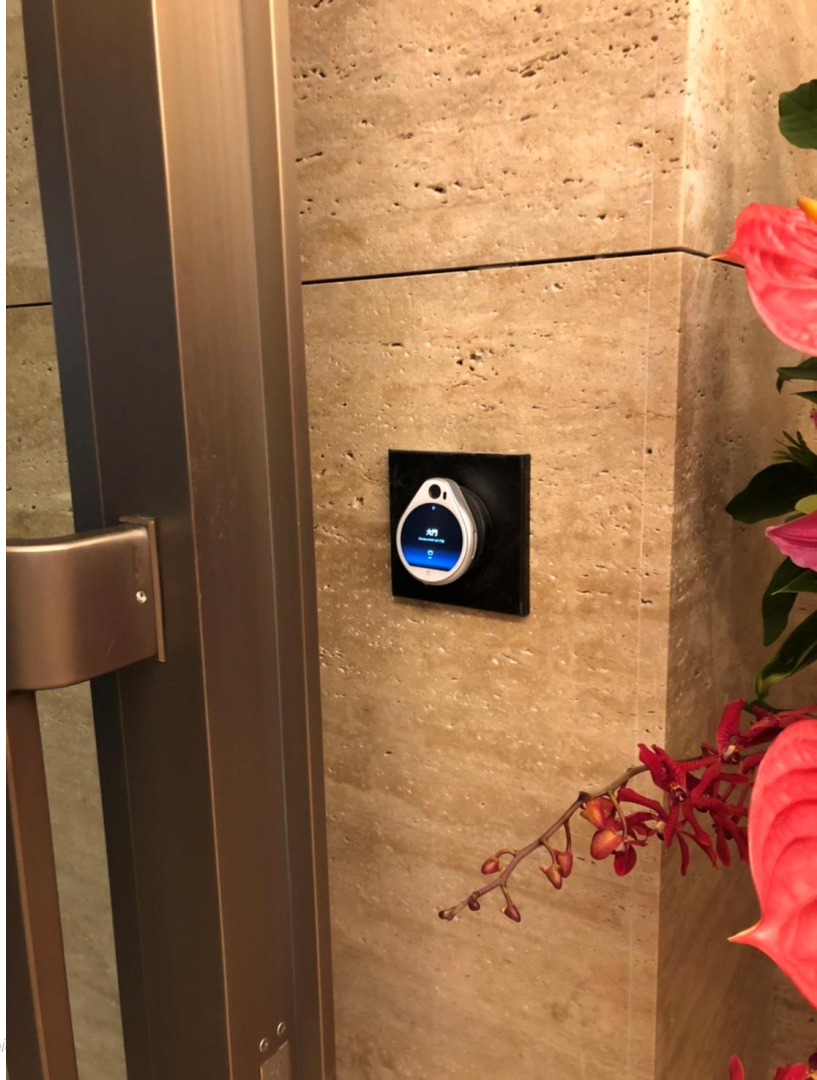





有限公司

誌慶

Cindy Chen 敬賀







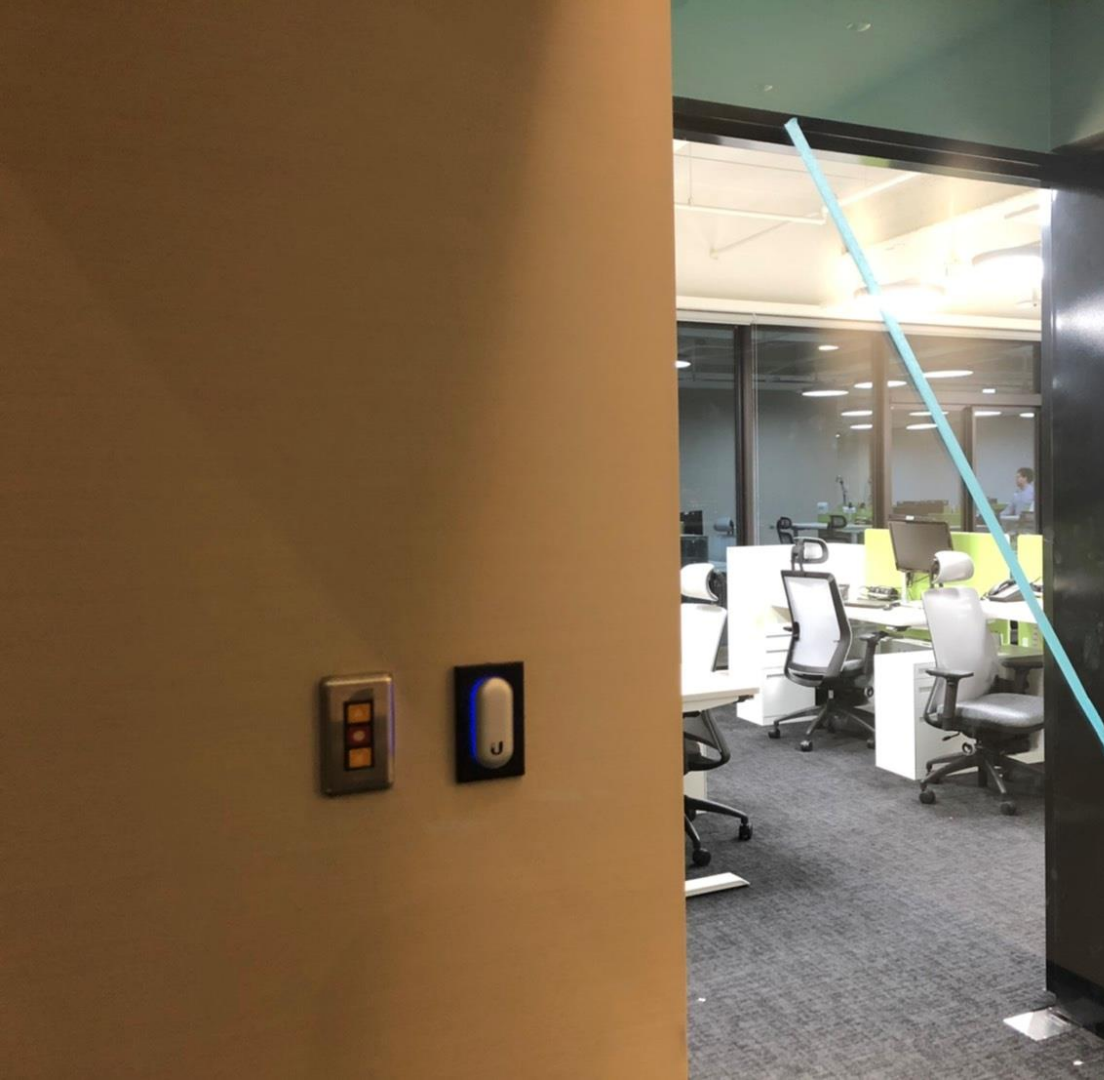







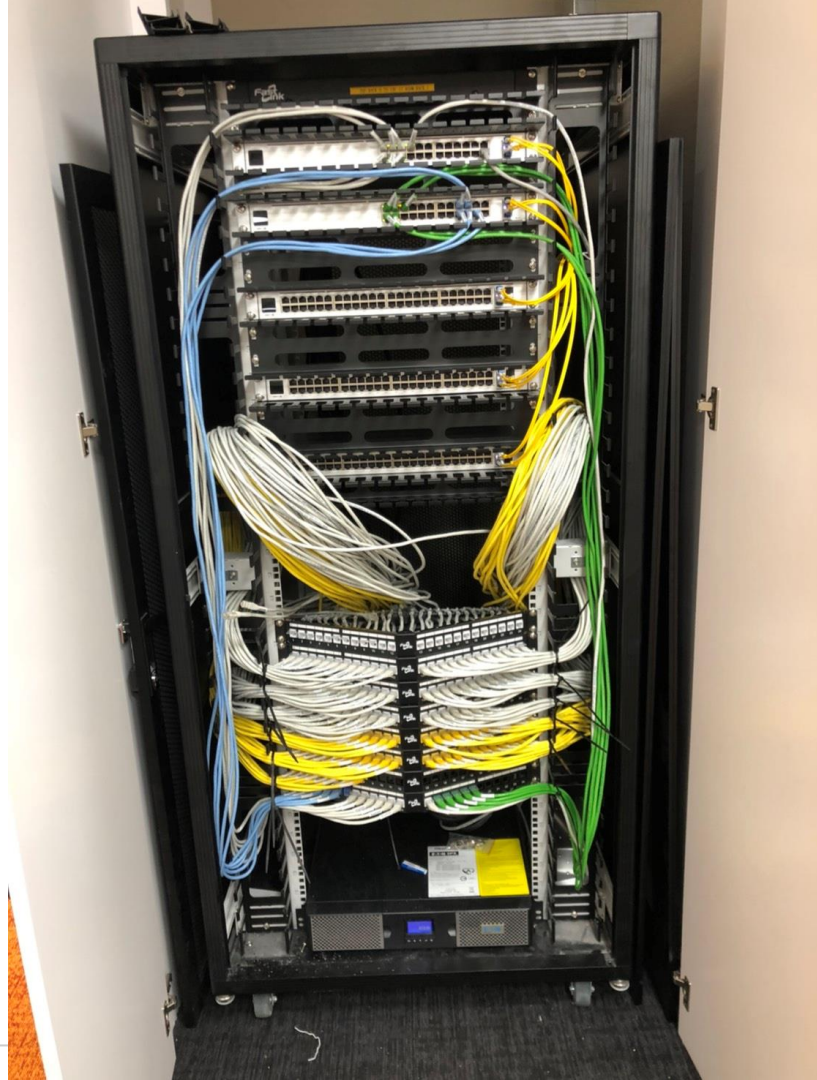
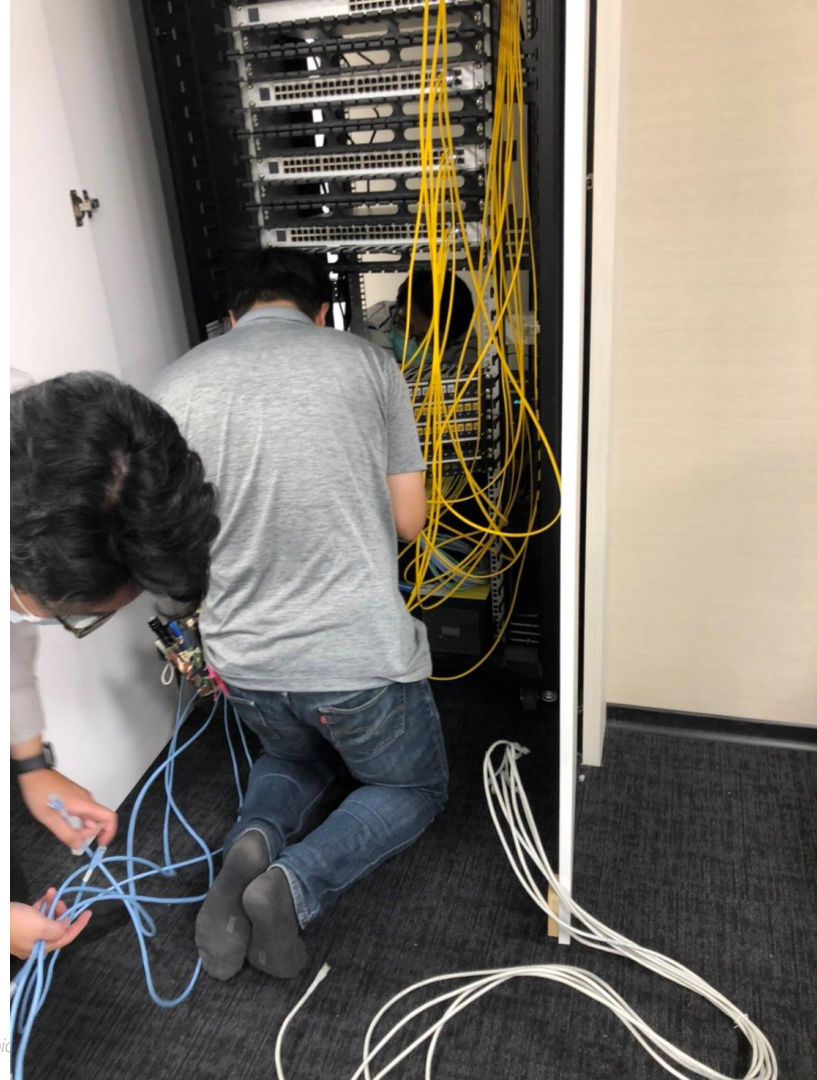



## C 1 Rack





Everything Is Great! | 96%

Theme

ISP Load: Unavailable

Network: Excellent

● Good ● Fair ● Poor

No UniFi Security Gateway detected. Routing info unavailable.



-  
Internet Capacity



-  
No Gateway Utilization



43  
Switches

39.9 Mbps ◀ ▶ 105 Kbps



42  
Access Points



34  
Clients WiFi



0  
Guests

WiFi Traffic Distribution 2.4GHz 5GHz



WiFi Metrics

Last 24 Hours Filter: Top 10 Access Points

Anomalies

6 Anomalies over 6 devices

5:00pm Long association time for Access Point  
[檔案總管 - P3](#)

Access Point Retry Rate

Retries per AP: ● 0 - 40% ● 40 - 66% ● 66 - 100%

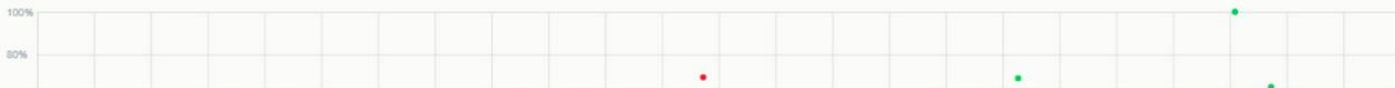

All (91)

Wireless (42)

Wired (49)

LTS (0)

EOL (0)

Overview

Performance

Config

Start rolling upgrade



DEVICE NAME ↑	IP ADDRESS	STATUS	WIFI EXPERIENCE	MODEL	CLIENTS	DOWN	UP	CHANNEL
21F-A-AP01	172.22.18.165	CONNECTED	No clients	UniFi AP-nanoHD	0	0B	0B	6 (ng), 161 (ac)
21F-A-AP02	172.22.18.178	CONNECTED	97%	UniFi AP-nanoHD	1	1.18 MB	817 KB	6 (ng), 161 (ac)
21F-A-AP03 法雅	172.22.18.169	CONNECTED	No clients	UniFi AP-nanoHD	0	0B	0B	6 (ng), 36 (ac)
21F-A-AP04	172.22.18.187	CONNECTED	100%	UniFi AP-nanoHD	1	333 KB	358 KB	11 (ng), 157 (ac)
21F-A-AP05	172.22.18.180	CONNECTED	75%	UniFi AP-nanoHD	1	11 KB	5.67 KB	1 (ng), 36 (ac)
21F-A-AP07	172.22.18.167	CONNECTED	No clients	UniFi AP-nanoHD	0	0B	0B	11 (ng), 36 (ac)
AP18F-2	172.22.18.30	CONNECTED	94%	UniFi AP-nanoHD	2	11.2 MB	13.8 MB	6 (ng), 36 (ac)
AP18F-A-P1	172.22.18.85	CONNECTED	99%	UniFi AP-nanoHD	6	56.7 MB	13.3 MB	6 (ng), 48 (ac)
AP18F-A-P3	172.22.18.74	CONNECTED	96%	UniFi AP-nanoHD	2	2.1 MB	2.14 MB	6 (ng), 161 (ac)
AP18F-A-P4	172.22.18.164	CONNECTED	No clients	UniFi AP-nanoHD	0	800 B	830 B	11 (ng), 161 (ac)
AP18F-A-P5	172.22.18.168	CONNECTED	90%	UniFi AP-nanoHD	1	1.49 MB	1.02 MB	1 (ng), 149 (ac)
AP18F-A-P6	172.22.18.177	CONNECTED	No clients	UniFi AP-nanoHD	0	271 KB	131 KB	11 (ng), 153 (ac)
AP18F-B-P1	172.22.18.160	CONNECTED	No clients	UniFi AP-nanoHD	0	0B	0B	11 (ng), 161 (ac)
AP18F-B-P3	172.22.18.174	CONNECTED	99%	UniFi AP-nanoHD	2	31.2 MB	21.9 MB	6 (ng), 157 (ac)
AP18F-B-P4	172.22.18.87	CONNECTED	99%	UniFi AP-nanoHD	3	535 MB	53.4 MB	1 (ng), 157 (ac)
AP18F-B-P5	172.22.18.188	CONNECTED	No clients	UniFi AP-nanoHD	0	6.56 KB	18.2 KB	11 (ng), 44 (ac)
AP18F-A-P1	172.22.18.170	CONNECTED	No clients	UniFi AP-nanoHD	0	0B	0B	11 (ng), 149 (ac)

# 各層樓數量(共36隻CAM)

TYPE	NAME	MODEL	IP ADDRESS
	Chenbro-NVR-18F-門禁	UDM-PRO	10.10.18.1

TYPE	NAME	MODEL	IP ADDRESS
	18F	UVC G3 Flex	192.168.118.234
	18F	UVC G3 Flex	192.168.118.22
	18F	UVC G3 Flex	192.168.118.60
	18F	UVC G3 Flex	192.168.118.228
	18F	UVC G3 Flex	192.168.118.73
	18F	UVC G3 Flex	192.168.118.223
	18F	UVC G3 Flex	192.168.118.164
	18F	UVC G3 Flex	192.168.118.19
	18F	UVC G3 Flex	192.168.118.68
	18F	UVC G3 Flex	192.168.118.227

TYPE	NAME	MODEL	IP ADDRESS
	Chenbro-NVR-21F	UDM-PRO	10.10.21.1

TYPE	NAME	MODEL	IP ADDRESS
	21F	UVC G3 Flex	192.168.121.230
	21F	UVC G3 Flex	192.168.121.62
	21F	UVC G3 Flex	192.168.121.229
	21F	UVC G3 Flex	192.168.121.72
	21F	UVC G3 Flex	192.168.121.125
	21F	UVC G3 Flex	192.168.121.224
	21F	UVC G3 Flex	192.168.121.75

TYPE	NAME	MODEL	IP ADDRESS
	Chenbro-NVR-19F	UDM-PRO	10.10.19.1

TYPE	NAME	MODEL	IP ADDRESS
	19F	UVC G3 Flex	192.168.119.43
	19F	UVC G3 Flex	192.168.119.242
	19F	UVC G3 Flex	192.168.119.14
	19F	UVC G3 Flex	192.168.119.168
	19F	UVC G3 Flex	192.168.119.190
	19F	UVC G3 Flex	192.168.119.245
	19F	UVC G3 Flex	192.168.119.253
	19F	UVC G3 Flex	192.168.119.142
	19F	UVC G3 Flex	192.168.119.8
	19F	UVC G3 Flex	192.168.119.233
	19F	UVC G3 Flex	192.168.119.243

TYPE	NAME	MODEL	IP ADDRESS
	Chenbro-NVR-20F	UDM-PRO	10.10.20.1

TYPE	NAME	MODEL	IP ADDRESS
	20F	UVC G3 Flex	192.168.120.99
	20F	UVC G3 Flex	192.168.120.39
	20F	UVC G3 Flex	192.168.120.100
	20F	UVC G3 Flex	192.168.120.78
	20F	UVC G3 Flex	192.168.120.90
	20F	UVC G3 Flex	192.168.120.49
	20F	UVC G3 Flex	192.168.120.17
	20F	UVC G3 Flex	192.168.120.22
	20F	UVC G3 Flex	192.168.120.65

